

INSTRUKCJA INSTALACJI PRZYCISKÓW AWARYJNYCH, MODELE APP, APPK, APW, APWK

TEST

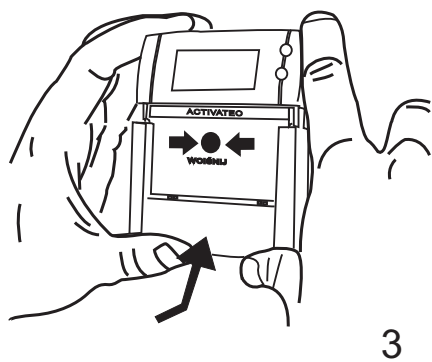

WYMIENIĆ SZYBKĘ/ZRESETOWAĆ ELEMENT

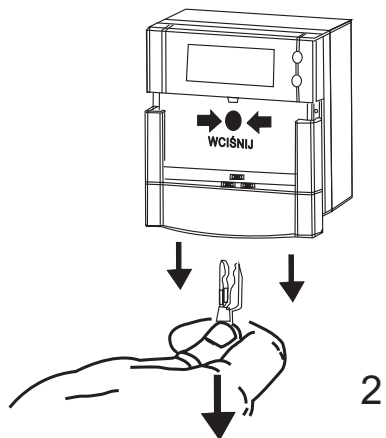
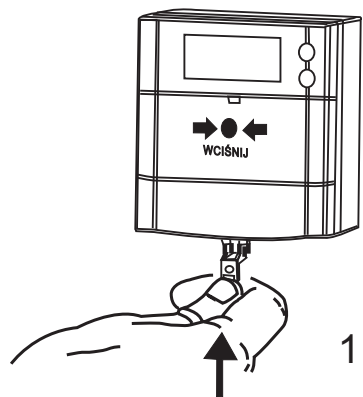
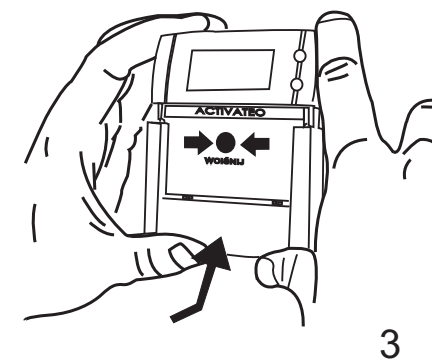
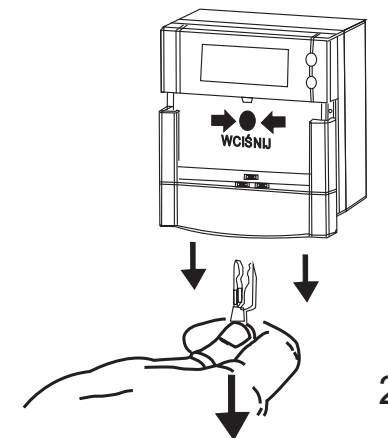
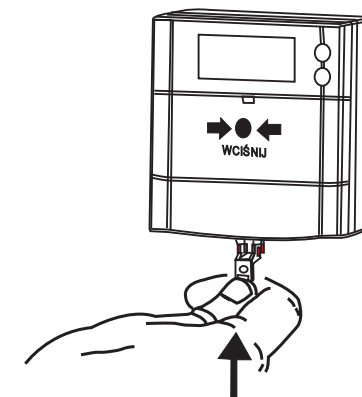
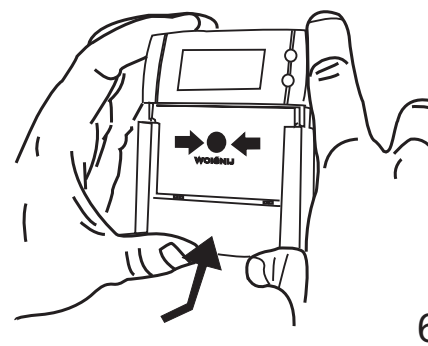
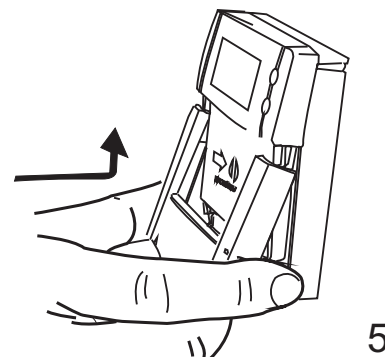
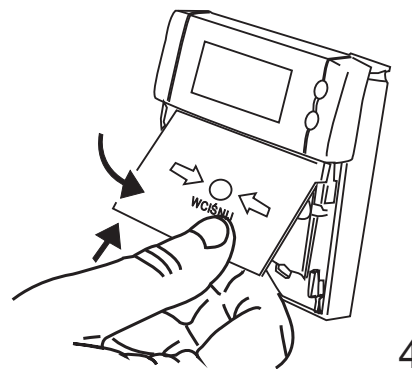
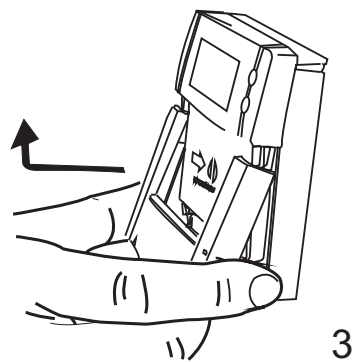
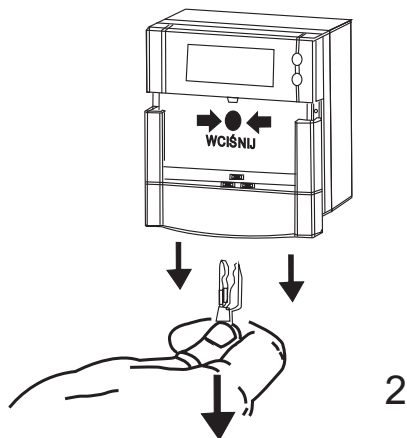
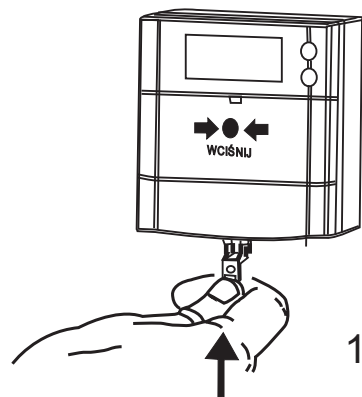

INSTRUKCJA INSTALACJI PRZYCISKÓW AWARYJNYCH, MODELE APP, APPK, APW, APWK

PODŁĄCZENIE	APxK-AX	APxK-BX	APxK-2AX	APxK-2BX

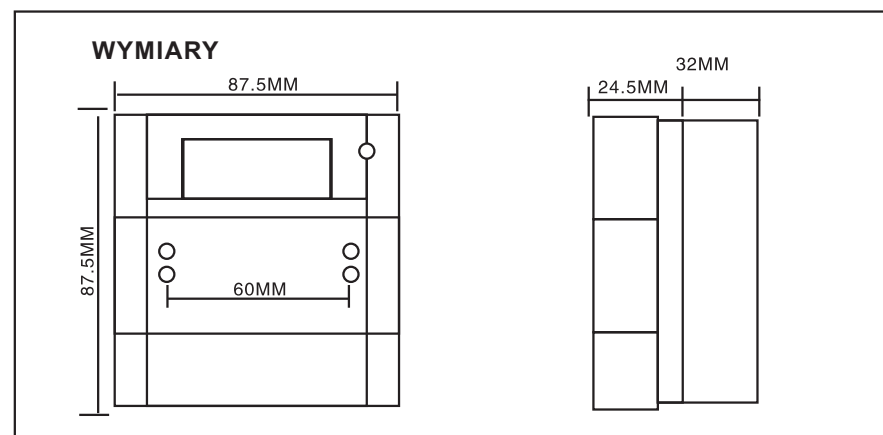

TERMINAL POŁĄCZENIOWY

Po podłączeniu przewodów do terminala zaciskowego, wsuń kostkę w odpowiednie miejsce, jak to ma miejsce na rysunku po lewej.

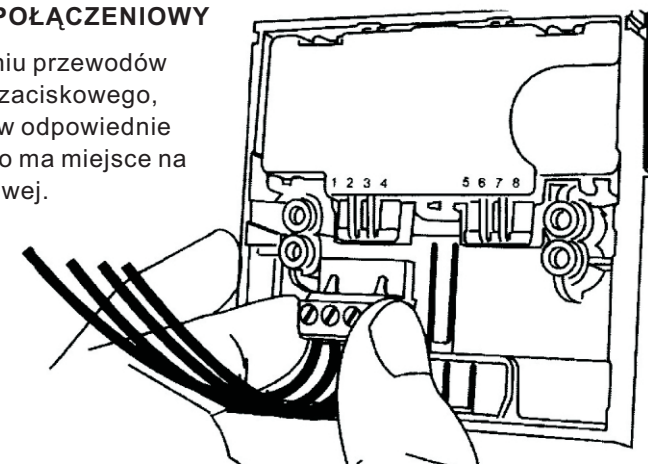

PODŁĄCZENIE	APxK	PODŁĄCZENIE	APxK

DANE TECHNICZNE



max 30VDC



-30°C to 70°C



max 2A



Czerwony, Ral 3001

Żółty, Ral 1006



IP24D

Zielony, Ral 6016

Biały, Ral 9010



110/160g

Niebieski, Ral 5002